

DAIKIN



INSTALLATION MANUAL

SPLIT SYSTEM Air Conditioners

MODELS

Ceiling mounted cassette type (Round flow model)

FCQ18PAVJU

FCQ24PAVJU

FCQ30PAVJU

FCQ36PAVJU

FCQ42PAVJU

English

Français

Español

Read these instructions carefully before installation.
Keep this manual in a handy place for future reference.

Lire soigneusement ces instructions avant l'installation.
Conserver ce manuel à portée de main pour référence ultérieure.

Lea cuidadosamente estas instrucciones antes de instalar.
Guarde este manual en un lugar a mano para leer en caso de tener alguna duda.

CONTENTS

1. SAFETY CONSIDERATIONS.....	1
2. BEFORE INSTALLATION.....	3
3. SELECTING INSTALLATION SITE	6
4. PREPARATIONS BEFORE INSTALLATION	7
5. INDOOR UNIT INSTALLATION.....	9
6. REFRIGERANT PIPING WORK.....	10
7. DRAIN PIPING WORK	13
8. ELECTRIC WIRING WORK.....	16
9. WIRING EXAMPLE AND HOW TO SET THE REMOTE CONTROLLER	17
10. INSTALLATION OF THE DECORATION PANEL.....	23
11. FIELD SETTING	24
12. TEST RUN	25

1. SAFETY CONSIDERATIONS

Read these “SAFETY CONSIDERATIONS for Installation” carefully before installing air conditioning equipment. After completing the installation, make sure that the unit operates properly during the startup operation. Instruct the customer on how to operate and maintain the unit. Inform customers that they should store this Installation Manual with the Operation Manual for future reference.

Always use a licensed installer or contractor to install this product. Improper installation can result in water or refrigerant leakage, electrical shock, fire, or explosion.

Meanings of DANGER, WARNING, CAUTION, and NOTE Symbols:



DANGER Indicates an imminently hazardous situation which, if not avoided, will result in death or serious injury.



WARNING Indicates a potentially hazardous situation which, if not avoided, could result in death or serious injury.



CAUTION Indicates a potentially hazardous situation which, if not avoided, may result in minor or moderate injury. It may also be used to alert against unsafe practices.



NOTE..... Indicates situations that may result in equipment or property-damage accidents only.



DANGER

- Refrigerant gas is heavier than air and replaces oxygen. A massive leak can lead to oxygen depletion, especially in basements, and an asphyxiation hazard could occur leading to serious injury or death.
- Do not ground units to water pipes, gas pipes, telephone wires, or lightning rods as incomplete grounding can cause a severe shock hazard resulting in severe injury or death. Additionally, grounding to gas pipes could cause a gas leak and potential explosion causing severe injury or death.
- If refrigerant gas leaks during installation, ventilate the area immediately. Refrigerant gas may produce toxic gas if it comes in contact with fire. Exposure to this gas could cause severe injury or death.
- After completing the installation work, check that the refrigerant gas does not leak throughout the system.
- Do not install unit in an area where flammable materials are present due to risk of explosions that can cause serious injury or death.

- Safely dispose all packing and transportation materials in accordance with federal/state/local laws or ordinances. Packing materials such as nails and other metal or wood parts, including plastic packing materials used for transportation may cause injuries or death by suffocation.
-

WARNING

- Only qualified personnel must carry out the installation work. Installation must be done in accordance with this installation manual. Improper installation may result in water leakage, electric shock, or fire.
 - When installing the unit in a small room, take measures to keep the refrigerant concentration from exceeding allowable safety limits. Excessive refrigerant leaks, in the event of an accident in a closed ambient space, can lead to oxygen deficiency.
 - Use only specified accessories and parts for installation work. Failure to use specified parts may result in water leakage, electric shocks, fire, or the unit falling.
 - Install the air conditioner on a foundation strong enough that it can withstand the weight of the unit. A foundation of insufficient strength may result in the unit falling and causing injuries.
 - Take into account strong winds, typhoons, or earthquakes when installing. Improper installation may result in the unit falling and causing accidents.
 - Make sure that a separate power supply circuit is provided for this unit and that all electrical work is carried out by qualified personnel according to local, state, and national regulations. An insufficient power supply capacity or improper electrical construction may lead to electric shocks or fire.
 - Make sure that all wiring is secured, that specified wires are used, and that no external forces act on the terminal connections or wires. Improper connections or installation may result in fire.
 - When wiring, position the wires so that the control box cover can be securely fastened. Improper positioning of the control box cover may result in electric shocks, fire, or the terminals overheating.
 - Before touching electrical parts, turn off the unit.
 - Be sure to install a ground fault circuit interrupter if one is not already available. This helps prevent electrical shocks or fire.
 - Securely fasten the outdoor unit terminal cover (panel). If the terminal cover/panel is not installed properly, dust or water may enter the outdoor unit causing fire or electric shock.
 - When installing or relocating the system, keep the refrigerant circuit free from substances other than the specified refrigerant (R410A) such as air. Any presence of air or other foreign substance in the refrigerant circuit can cause an abnormal pressure rise or rupture, resulting in injury.
 - Do not change the setting of the protection devices. If the pressure switch, thermal switch, or other protection device is shorted and operated forcibly, or parts other than those specified by Daikin are used, fire or explosion may occur.
-

CAUTION

- Do not touch the switch with wet fingers. Touching a switch with wet fingers can cause electric shock.
- Do not allow children to play on or around the unit to prevent injury.
- Do not touch the refrigerant pipes during and immediately after operation as the refrigerant pipes may be hot or cold, depending on the condition of the refrigerant flowing through the refrigerant piping, compressor, and other refrigerant cycle parts. Your hands may suffer burns or frostbite if you touch the refrigerant pipes. To avoid injury, give the pipes time to return to normal temperature or, if you must touch them, be sure to wear proper gloves.
- Heat exchanger fins are sharp enough to cut.
To avoid injury wear glove or cover the fins when working around them.
- Install drain piping to proper drainage. Improper drain piping may result in water leakage and property damage.
- Insulate piping to prevent condensation.
- Be careful when transporting the product.
- Do not turn off the power immediately after stopping operation. Always wait for at least 5 minutes before turning off the power. Otherwise, water leakage may occur.
- Do not use a charging cylinder. Using a charging cylinder may cause the refrigerant to deteriorate.

- Refrigerant R410A in the system must be kept clean, dry, and tight.
 - (a) Clean and Dry -- Foreign materials (including mineral oils such as SUNISO oil or moisture) should be prevented from getting into the system.
 - (b) Tight -- R410A does not contain any chlorine, does not destroy the ozone layer, and does not reduce the earth's protection against harmful ultraviolet radiation. R410A can contribute to the greenhouse effect if it is released. Therefore take proper measures to check for the tightness of the refrigerant piping installation. Read the chapter Refrigerant Piping Work and follow the procedures.
- Since R410A is a blend, the required additional refrigerant must be charged in its liquid state. If the refrigerant is charged in a state of gas, its composition can change and the system will not work properly.
- The indoor unit is for R410A. See the catalog for indoor models that can be connected. Normal operation is not possible when connected to other units.
- Indoor units are for indoor installation only. Outdoor units can be installed either outdoors or indoors.
- Do not install the air conditioner in the following locations:
 - (a) Where a mineral oil mist or oil spray or vapor is produced, for example, in a kitchen. Plastic parts may deteriorate and fall off or result in water leakage.
 - (b) Where corrosive gas, such as sulfuric acid gas, is produced. Corroding copper pipes or soldered parts may result in refrigerant leakage.
 - (c) Near machinery emitting electromagnetic waves. Electromagnetic waves may disturb the operation of the control system and cause the unit to malfunction.
 - (d) Where flammable gas may leak, where there is carbon fiber, or ignitable dust suspension in the air, or where volatile flammables such as thinner or gasoline are handled. Operating the unit in such conditions can cause a fire.
- Take adequate measures to prevent the outdoor unit from being used as a shelter by small animals. Small animals making contact with electrical parts can cause malfunctions, smoke, or fire. Instruct the customer to keep the area around the unit clean.

 **NOTE**

- Install the power supply and control wires for the indoor and outdoor units at least 3.5 feet away from televisions or radios to prevent image interference or noise. Depending on the radio waves, a distance of 3.5 feet may not be sufficient to eliminate the noise.
- Dismantling the unit, treatment of the refrigerant, oil and additional parts must be done in accordance with the relevant local, state, and national regulations.
- Do not use the following tools that are used with conventional refrigerants: gauge manifold, charge hose, gas leak detector, reverse flow check valve, refrigerant charge base, vacuum gauge, or refrigerant recovery equipment.
- If the conventional refrigerant and refrigerator oil are mixed in R410A, the refrigerant may deteriorate.
- This air conditioner is an appliance that should not be accessible to the general public.
- The wall thickness of field-installed pipes should be selected in accordance with the relevant local, state, and national regulations.

2. BEFORE INSTALLATION

Do not exert pressure on the resin parts when opening the unit or when moving it after opening. Be sure to check the type of R410A refrigerant to be used before doing any work. (Using an incorrect refrigerant will prevent normal operation of the unit.)





- When opening the unit or moving it after opening, be sure to lift it by holding on to the lifting lugs without exerting any pressure on other parts, especially, drain piping, and other resin parts.
- Decide upon a line of transport.
- Leave the unit inside its packaging while moving, until reaching the installation site. Use a sling of soft material, where unpacking is unavoidable or protective plates together with a rope when lifting, to avoid damage or scratches to the unit.
- Refer to the installation manual of the outdoor unit for items not described in this manual.
- Do not dispose of any parts necessary for installation until the installation is complete.







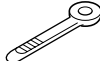

1. PRECAUTIONS

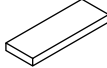

- Be sure to read this manual before installing the indoor unit.
- When selecting installation site, refer to the paper pattern.
- This unit is suitable for installation in a household, commercial and light industrial environment.
- Do not install or operate the unit in rooms mentioned below.
 - Laden with mineral oil, or filled with oil vapor or spray like in kitchens. (Plastic parts may deteriorate.)
 - Where corrosive gas like sulfurous gas exists. (Copper tubing and brazed spots may corrode.)
 - Where volatile flammable gas like thinner or gasoline is used.
 - Where machines can generate electromagnetic waves. (Control system may malfunction.)
 - Where the air contains high levels of salt such as that near the ocean and where voltage fluctuates greatly such as that in factories. Also in vehicles or vessels.

2. ACCESSORIES

Check the following accessories are included with your unit.

Name	(1) Drain hose	(2) Metal clamp	(3) Washer for hanger bracket	(4) Clamp	(5) Paper pattern for installation
Quantity	1 pc.	1 pc.	8 pcs.	6 pcs.	1 pc.
Shape					Also used as packing material 

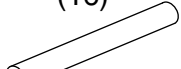
Name	(6) Screw (M4)	(7) Washer fixing plate	Insulation for fitting	Sealing pad		
Quantity	4 pcs.	4 pcs.	1 each	1 each	1 pc.	1 pc.
Shape	For paper pattern for installation 		(8) for gas pipe  (9) for liquid pipe 	(10) Large  (11) Medium-1  (12) Medium-2 	(13) Small 	(14) 

Name	Installation guide	Insulation tube	Conduit mounting plate	(Other)
Quantity	1 pc.	1 pc.	1 each	
Shape	(15) 	(16) 	(17)  (18) 	<ul style="list-style-type: none"> • Installation manual • Operation manual

3. OPTIONAL ACCESSORIES

- The optional decoration panel and remote controller are required for this indoor unit. (Refer to Table 1, 2)
(However, the remote controller is not required for the slave unit of a simultaneous operation system.)

Table 1

Unit model	Optional decoration panel
FCQ18 · 24 · 30 · 36 · 42PAVJU	BYCP125K-W1
	Color : Fresh white

Table 2

Remote controller	
Wired type	BRC1E71/BRC1D71

NOTE

- If you wish to use a remote controller that is not listed in “Table 2” on page 5, select a suitable remote controller after consulting catalogs and technical materials.

FOR THE FOLLOWING ITEMS, TAKE SPECIAL CARE DURING CONSTRUCTION AND CHECK AFTER INSTALLATION IS FINISHED.

1. Items to be checked after completion of work

Items to be checked	If not properly done, what is likely to occur	Check
Are the indoor unit and outdoor unit fixed firmly?	The unit may drop, vibrate or make noise.	
Is the outdoor unit fully installed?	The unit may malfunction or the components burn out.	
Is the gas leak test finished?	It may result in insufficient cooling.	
Is the unit fully insulated?	Condensate water may drip.	
Does drainage flow smoothly?	Condensate water may drip.	
Does the power supply voltage correspond to that shown on the name plate?	The unit may malfunction or the components burn out.	
Are wiring and piping correct?	The unit may malfunction or the components burn out.	
Is the unit safely grounded?	It may result in electric shock.	
Is wiring size according to specifications?	The unit may malfunction or the components burn out.	
Is something blocking the air outlet or inlet of either the indoor or outdoor units?	It may result in insufficient cooling.	
Are refrigerant piping length and additional refrigerant charge noted down?	The refrigerant charge in the system is not clear.	

2. Items to be checked at time of delivery

* Also review the “1. SAFETY CONSIDERATIONS”

Items to be checked	Check
Are the control box cover, air filter, suction grille attached?	
Did you explain about operations while showing the operation manual to your customer?	
Did you hand the operation manual over to your customer?	

Points for explanation about operations

The items with **⚠ WARNING** and **⚠ CAUTION** marks in the operation manual are the items pertaining to possibilities for bodily injury and material damage in addition to the general usage of the product. Accordingly, it is necessary that you make a full explanation about the described contents and also ask your customers to read the operation manual.

4. NOTE TO THE INSTALLER

Be sure to instruct customers how to properly operate the unit (especially cleaning filters, operating different functions, and adjusting the temperature) by having them carry out operations themselves while looking at the manual.

3. SELECTING INSTALLATION SITE

⟨Hold the unit by the 4 lifting lugs when opening the box and moving it, and do not exert pressure on to any other part piping (refrigerant, drain, etc.) or plastic parts.

If the temperature or humidity inside the ceiling might rise above 86°F or RH 80%, respectively, use the high-humidity kit (sold separately) or add extra insulation to the main unit body.

Use glass wool or polyethylene foam as insulation and make sure it is at least 3/8in. thick and fits inside the ceiling opening.⟩

The direction this product blows can be selected. However, a separately sold shut-off material kit is needed in order to make the unit blow in two, three, or four (corner shut-off) directions.

(1) Select an installation location with the customer's approval which matches the following conditions.

- A location from which cool (warm) air will reach the whole room.
- A location with no objects blocking the air passage.
- A location where drainage can be done with no problem.
- A location strong enough to support the weight of the indoor unit.
- Locations where the wall is not significantly tilted.
- A location which leaves enough room for installation and service work.
- A location where there is no risk of flammable gas leaking.
- A location where the length of the indoor-outdoor piping is no longer than the tolerated length (see the installation manual that came with the outdoor unit for details).

[Space required for installation]

(Unit: in.)

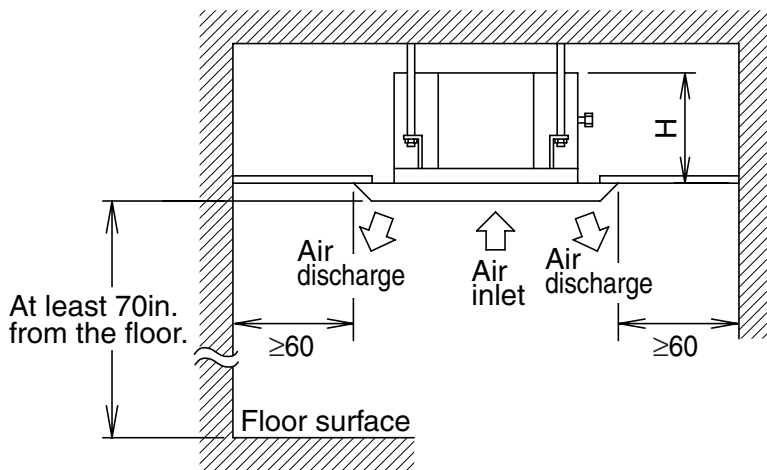

Fig. 1

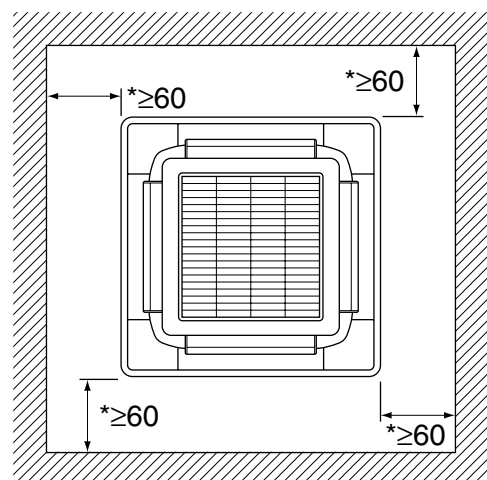

Fig. 2

Model	H (in.)
FCQ18 · 24 · 30PAVJU	10
FCQ36 · 42PAVJU	11-3/4

CAUTION

- The indoor and outdoor units and the power supply wiring and remote controller wire must be installed at least 40in. away from any televisions or radios. This is to prevent interference with picture and sound reception. (Interference may occur even at 40in. away depending on the reception quality.)

(2) Ceiling height

This product can be installed in ceilings up to 11-1/2ft. high (13-3/4ft. high for the 36 and 42).

If the ceiling height is 8-3/4ft. (10-1/2ft. for the 36 and 42) or more, field settings will have to be made with the remote controller. See "11. FIELD SETTING" for details.

(3) Air direction

The air direction shown in Fig. 3 is an example.

Select the appropriate number of directions according to the shape of the room and the location of the unit. (Field settings have to be made using the remote controller and the outlet vents have to be shut off if two, three, or four (corner shut-off) directions are selected. See the shut-off materials (sold separately) installation manual for details.)

- (4) Use suspension bolts for installation. Check if the location for the installation is strong enough to support the weight of the unit, reinforce it if necessary, and install using suspension bolts. (The spacing of the installation is shown on the "paper pattern for installation (5)".)

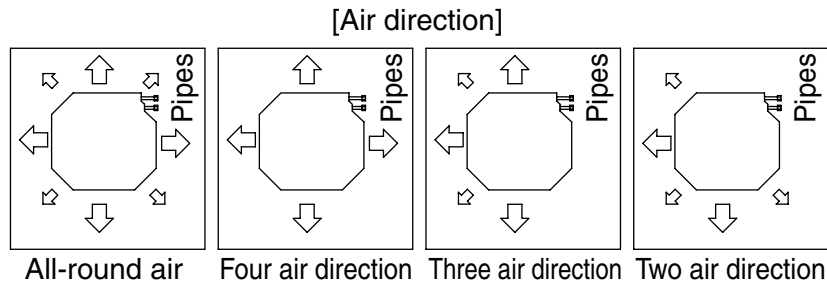
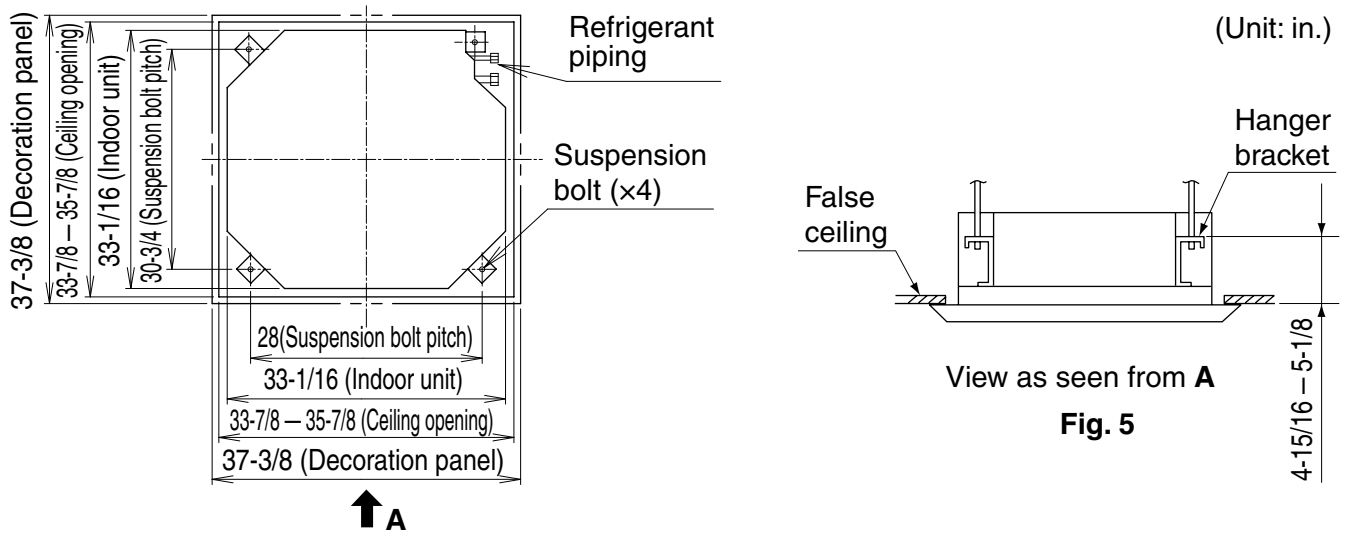

Fig. 3

4. PREPARATIONS BEFORE INSTALLATION

(1) Relation of ceiling opening to unit and suspension bolt position.



■ Installation is possible when ceiling opening dimensions is as follows

- When installing the unit within the frame for fixing false ceiling.

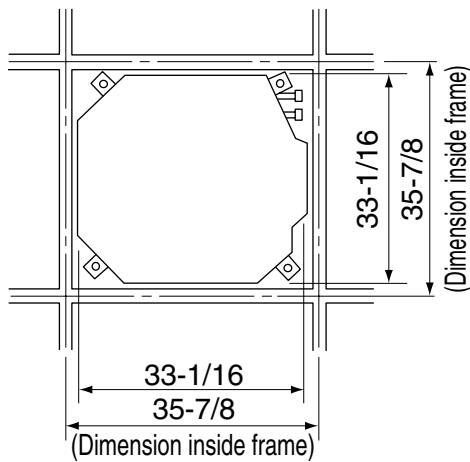

Fig. 6

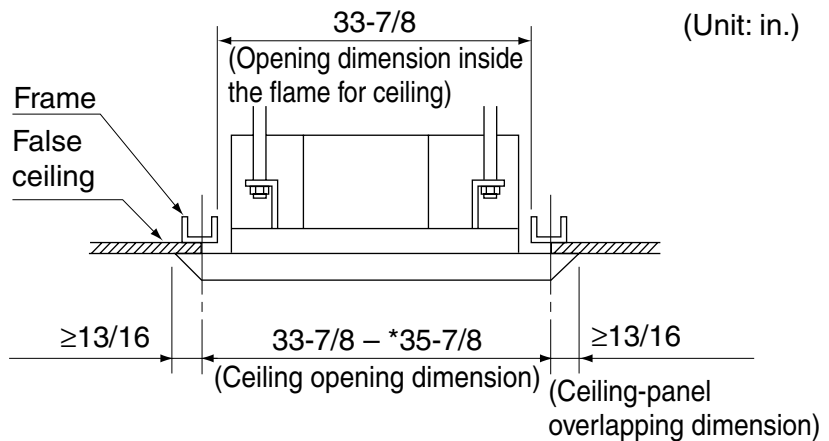

Fig. 7

NOTE

- Installation is possible with a ceiling dimension of 35-7/8in. (marked with *). However, to achieve a ceiling-panel overlapping dimension of 13/16in., the spacing between the ceiling and the unit should be 1-3/8in. or less. If the spacing between ceiling and the unit is over 1-3/8in., attach ceiling material to ■ part or recover the ceiling.

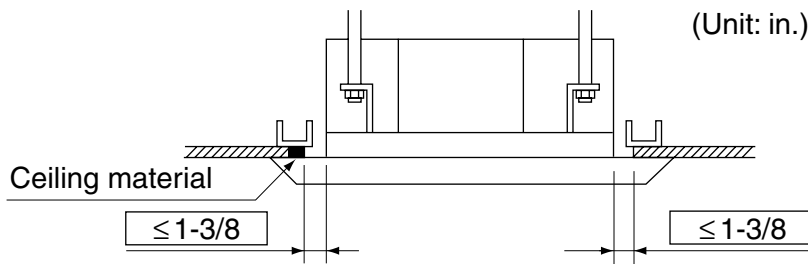

Fig. 8

(2) Make the ceiling opening needed for installation where applicable. (For existing ceilings)

- Refer to the paper pattern for installation (5) for ceiling opening dimensions.
- Create the ceiling opening required for installation. From the side of the opening to the casing outlet, implement the refrigerant and drain piping and wiring for remote controller (unnecessary for wireless type) and indoor-outdoor unit casing outlet. Refer to “6. REFRIGERANT PIPING WORK”, “7. DRAIN PIPING WORK” and “8. ELECTRIC WIRING WORK”.
- After making an opening in the ceiling, it may be necessary to reinforce ceiling beams to keep the ceiling level and to prevent it from vibrating. Consult the builder for details.

(3) Install the suspension bolts.

(Use either a M8~M10 size bolt or the equivalent)
Use a hole-in anchor for existing ceilings, and a sunken insert, sunken anchor or other field supplied parts for new ceilings to reinforce the ceiling to bear the weight of the unit. Adjust clearance (2-4in.) from the ceiling before proceeding further.

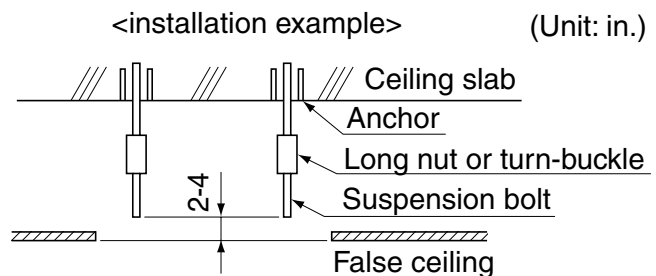

Fig. 9

NOTE

- All the above parts are field supplied.

5. INDOOR UNIT INSTALLATION

Installing optional accessories (except for the decoration panel) before installing the indoor unit is easier. However, for existing ceilings, install fresh air inlet component kit and branch duct before installing the unit.

As for the parts to be used for installation work, be sure to use the provided accessories and specified parts designated by our company.

(1) For new ceilings

(1-1) Install the indoor unit temporarily.

- Attach the hanger bracket to the suspension bolt. Be sure to fix it securely by using a nut and washer (3) from the upper and lower sides of the hanger bracket. The washer fixing plate (7) will prevent the washer from falling.

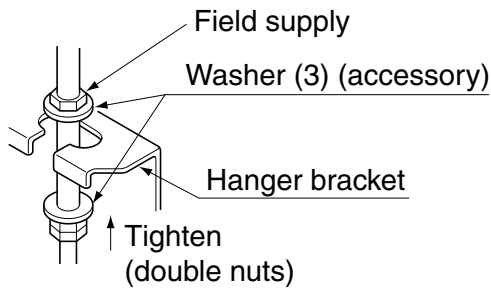

[Securing the hanger bracket]

Fig. 10

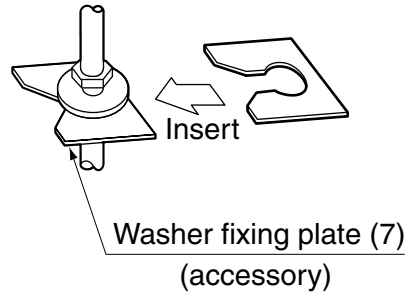

[Securing the washer]

Fig. 11

(1-2) Refer to the paper pattern for installation (5) for ceiling opening dimension.

Consult the builder or carpenter for details.

- The center of the ceiling opening is indicated on the paper pattern for installation. The center of the unit is indicated on the triangular mark to the unit bottom and on the paper pattern for installation.
- Fix the paper pattern to the unit with screws (6) (×4).
- Ceiling height is shown on the side of the paper pattern for installation (5). Adjust the height of the unit according to this indication.

Please perform one of the following, as the shape of the paper pattern for installation differs according to the model.

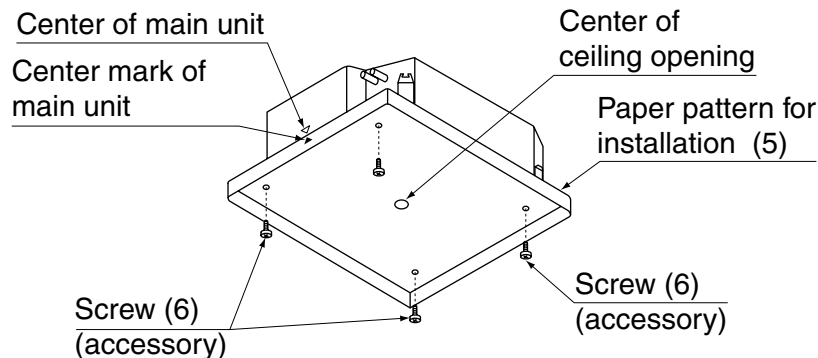

Fig. 12

[Installation of paper pattern for installation]

<Ceiling work>

(1-3) Adjust the unit to the right position for installation.

(Refer to “4. PREPARATIONS BEFORE INSTALLATION-(1)”.)

- Using the Installation guide (15) allows you to check the positions from the underside of the unit to the lower ceiling surface.

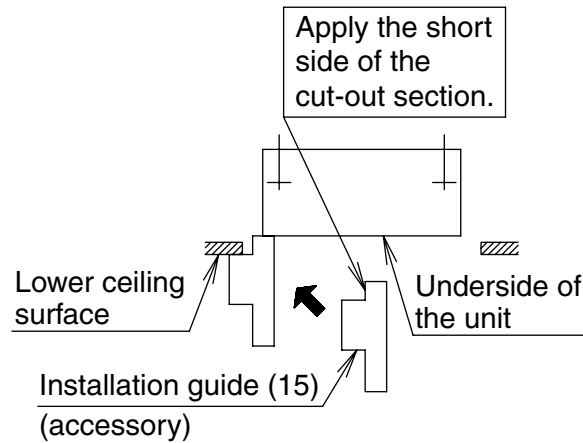

(1-4) Check the unit is horizontally level.

- The indoor unit is equipped with a built-in drain pump and float switch. Verify that it is level by using a level or a water-filled vinyl tube.

— CAUTION

If the unit is tilted against condensate flow, the float switch may malfunction and cause water to drip.

(1-5) Remove the washer fixing plate (7) used for preventing the washer from falling and tighten the upper nut.

(1-6) Remove the paper pattern for installation (5).

(2) For existing ceilings

(2-1) Install the indoor unit temporarily.

Perform step (1-1) in (1) For new ceilings.

(2-2) Adjust the height and position of the unit.

(Refer to “4. PREPARATIONS BEFORE INSTALLATION-(1)” and (1-3) in (1) For new ceilings.)

(2-3) Perform steps (1-4), (1-5) in (1) For new ceilings.

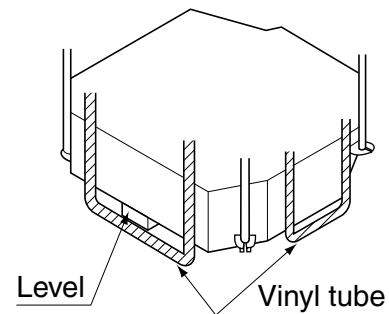

[Maintaining horizontality]

Fig. 13

6. REFRIGERANT PIPING WORK

<For refrigerant piping of outdoor units, see the installation manual attached to the outdoor unit.>

<Execute heat insulation work completely on both sides of the gas piping and the liquid piping. Otherwise, a water leakage can result sometimes.>

(When using a heat pump, the temperature of the gas piping can reach up to approximately 250°F, so use insulation which is sufficiently resistant.)

<Also, in cases where the temperature and humidity of the refrigerant piping sections might exceed 86°F or RH80%, reinforce the refrigerant insulation. (13/16in. or thicker) Condensate may form on the surface of the insulating material.>

<Be sure to check the type of R410A refrigerant to be used before doing any work. (Using an incorrect refrigerant will prevent normal operation of the unit.)>

CAUTION

- Use a pipe cutter and flare suitable for the type of refrigerant.
- Apply ester oil or ether oil around the flare section before connecting.
- To prevent dust, moisture or other foreign matter from infiltrating the tube, either pinch the end or cover it with tape.
- Do not allow anything other than the designated refrigerant to get mixed into the refrigerant circuit, such as air, etc. If any refrigerant gas leaks while working on the unit, ventilate the room thoroughly right away.

- **Do not mix air or other gas with the specified refrigerant in the refrigeration cycle.**
- **Ventilate the room if refrigerant gas leaks during the work.**
- The outdoor unit is charged with refrigerant.
- Be sure to use both a spanner and torque wrench together, as shown in the drawing, when connecting or disconnecting pipes to/from the unit. **(Refer to Fig. 14)**
- Refer to “Table 3” for the dimensions of flare nut spaces.

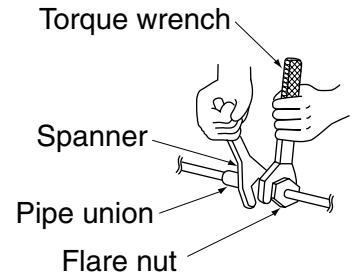

Fig. 14

- When connecting the flare nut, apply ester oil or ether oil to the flare section (outside only), and spin 3-4 times before screwing in. **(Refer to Fig. 15)**
- **Keep all the screw mounting resin parts (e.g., piping presser plates) away from oil.**
If oil adheres, the strength of the screw mounting resin parts may drop.

Coat here with ester or etheroil.

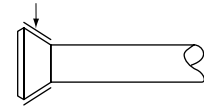

Fig. 15

CAUTION

Over-tightening the flare nut may break it and/or cause the refrigerant to leak.

NOTE

- Use the flare nut included with the unit main body.

Table 3

Pipe size	Tightening torque	Flare dimensions A (in.)	Flare shape
φ 1/4	10.4 – 12.7lbf·ft.	0.342 – 0.358	<p>The technical drawing shows a side view of a flare. It features a 90-degree angle with a tolerance of ±2 degrees. The flare itself is at a 45-degree angle with a tolerance of ±2 degrees. The width of the flare is labeled as 'A'. The radius of the flare is specified as R0.016-0.031.</p>
φ 3/8	24.1 – 29.4lbf·ft.	0.504 – 0.520	
φ 1/2	36.5 – 44.5lbf·ft.	0.638 – 0.654	
φ 5/8	45.6 – 55.6lbf·ft.	0.760 – 0.776	

- Refer to “Table 3” to determine the proper tightening torque.

— Not recommendable but in case of emergency —

You must use a torque wrench but if you are obliged to install the unit without a torque wrench, you may follow the installation method mentioned below.

When you keep on tightening the flare nut with a spanner, there is a point where the tightening torque suddenly increases. From that position, further tighten the flare nut the angle shown below:

Pipe size	Further tightening angle	Recommended arm length of tool
φ 1/4	60 to 90 degrees	Approx. 6in.
φ 3/8	60 to 90 degrees	Approx. 8in.
φ 1/2	30 to 60 degrees	Approx. 10in.
φ 5/8	30 to 60 degrees	Approx. 12in.

After the work is finished, make sure to check that there is no gas leak.

- Make absolutely sure to execute heat insulation works on the pipe-connecting section after checking gas leakage by thoroughly studying the following figure and using the attached heat insulating materials for fitting (8) and (9). (Fasten both ends with the clamps (4).) **(Refer to Fig. 16)**
- Wrap the sealing pad (11) only around the insulation for the joints on the gas piping side. **(Refer to Fig. 16)**

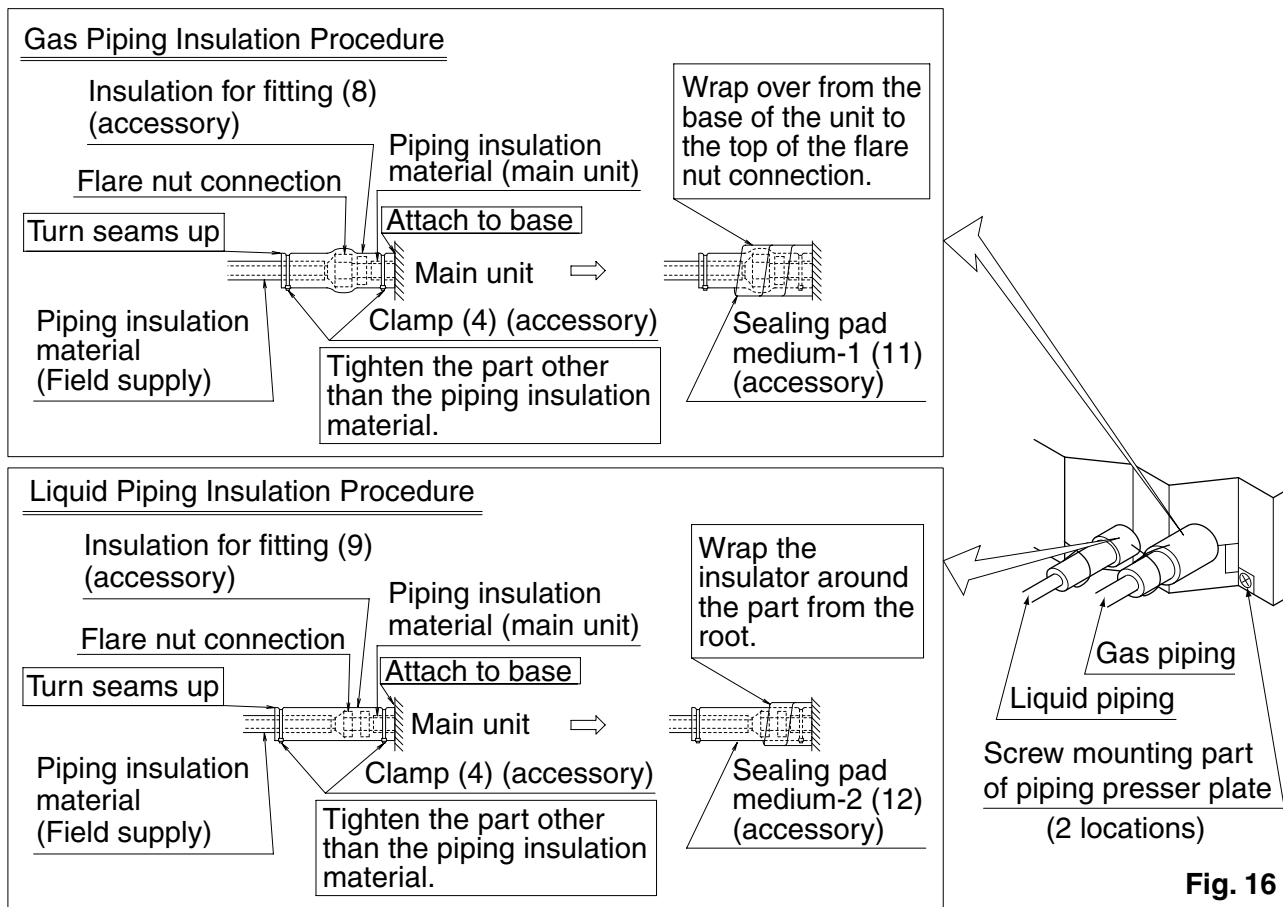

Fig. 16

⚠ CAUTION

For field insulation, be sure to insulate field piping all the way into the pipe connections inside the machine. Exposed piping may cause condensation or burns on contact.

CAUTION

CAUTION TO BE TAKEN WHEN BRAZING REFRIGERANT PIPING

“Do not use flux when brazing refrigerant piping. Therefore, use the phosphor copper brazing filler metal (BCuP-2/B-Cu93P-710/795) which does not require flux.”

(Flux has extremely harmful influence on refrigerant piping systems. For instance, if the chlorine based flux is used, it will cause pipe corrosion or, in particular, if the flux contains fluorine, it will damage the refrigerant oil.)

- Before brazing field refrigerant piping, nitrogen gas shall be blown through the piping to expel air from the piping.
If you brazing is done without nitrogen gas blowing, a large amount of oxide film develops inside the piping, and could cause system malfunction.
- When brazing the refrigerant piping, only begin brazing after having carried out nitrogen substitution or while inserting nitrogen into the refrigerant piping. Once this is done, connect the indoor unit with a flared or a flanged connection.
- Nitrogen should be set to 2.9psi with a pressure-reducing valve if brazing while inserting nitrogen into the piping. (Refer to Fig. 17)

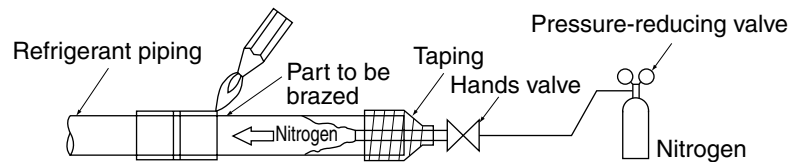
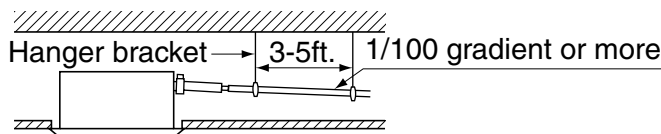

Fig. 17

7. DRAIN PIPING WORK

(1) Rig drain piping

- As for drain work, perform piping in such a manner that water can be drained properly.
- Employ a pipe with either the same diameter or with the diameter larger (excluding the raising section) than that of the connecting pipe (PVC pipe, nominal diameter 1in., outside diameter 1-1/4in.).
- Keep the drain pipe short and sloping downwards at a gradient of at least 1/100 to prevent air pockets from forming.
- If the drain pipe cannot be sufficiently set on a slope, execute the drain raising piping.
- To keep the drain pipe from sagging, space hanger bracket every 3 to 5ft..



GOOD O

Fig. 18-1

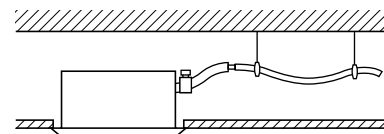

WRONG X

Fig. 18-2

CAUTION

Water pooling in the drainage piping can cause the drain to clog.

- Use the attached drain hose (1) and metal clamp (2).
- Insert the drain hose into the drain socket up to the base, and tighten the metal clamp securely within the portion of a white tape of the hose-inserted tip. Tighten the metal clamp until the screw head is less than 5/32in. from the hose.
- Wrap the attached sealing pad (10) over the metal clamp and drain hose to insulate.

- Make sure that heat insulation work is executed on the following 2 spots to prevent any possible water leakage due to dew condensation.
 - Indoor drain pipe
 - Drain socket

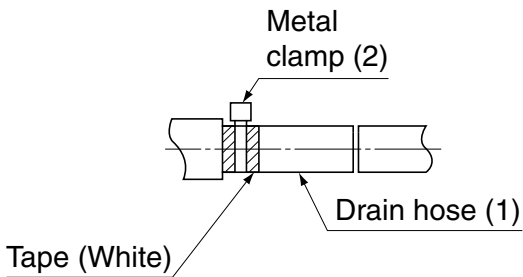

Fig. 19

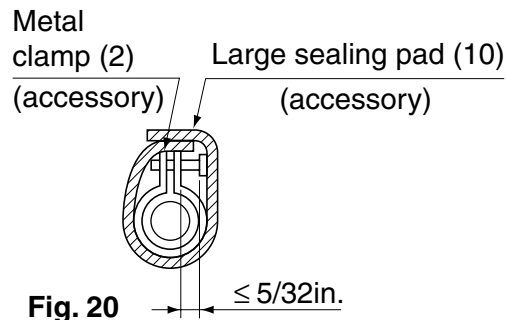

Fig. 20

<PRECAUTIONS FOR DRAIN RAISING PIPING>

- Install the drain raising pipes at a height of less than 26-1/2in..
The drain pump of this unit has a high delivery flow rate. Therefore, the higher the drain raising height is, the lower the sound of draining will be. For this reason, a minimum drain raising height of 12in. is recommended.
- Install the drain raising pipes at a right angle to the indoor unit and no more than 11-3/4in. from the unit.

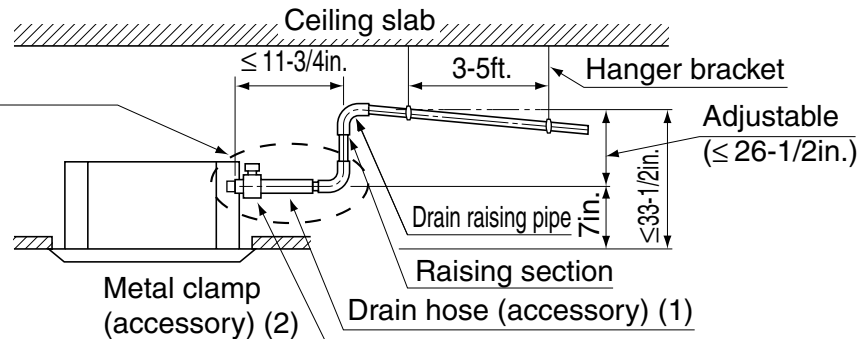
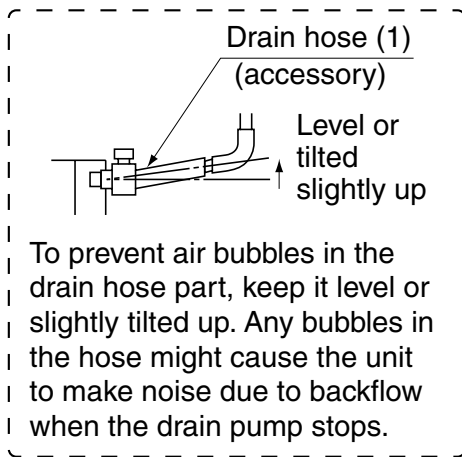

Fig. 21

NOTE

- To ensure no excessive pressure is applied to the included drain hose (1), do not bend or twist when installing. (This may cause leakage.)
- If converging multiple drain pipes, install according to the procedure shown below.

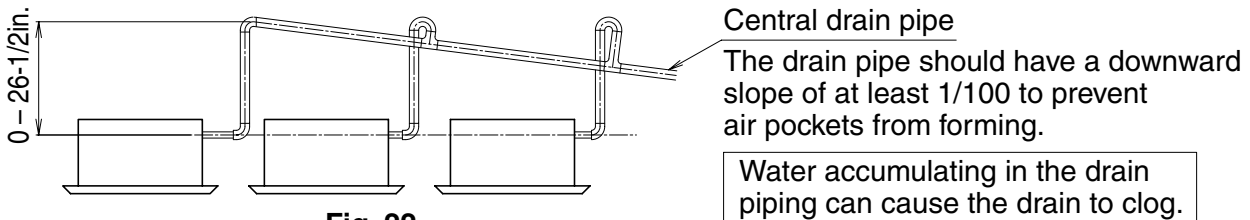

Fig. 22

Select converging drain pipes whose gauge is suitable for the operating capacity of the unit.

(2) After piping work is finished, check if drainage flows smoothly.

WHEN ELECTRIC WIRING WORK IS FINISHED

- Add approximately 1/4gal. of water slowly from the air outlet and check drainage flow.
- Check drainage flow during COOL running, explained under “12. TEST RUN”.
- Refer to the figure on the following after checking the draining of water, and mount the thermal insulation material for drainage (14) and thermal insulate the drain socket.

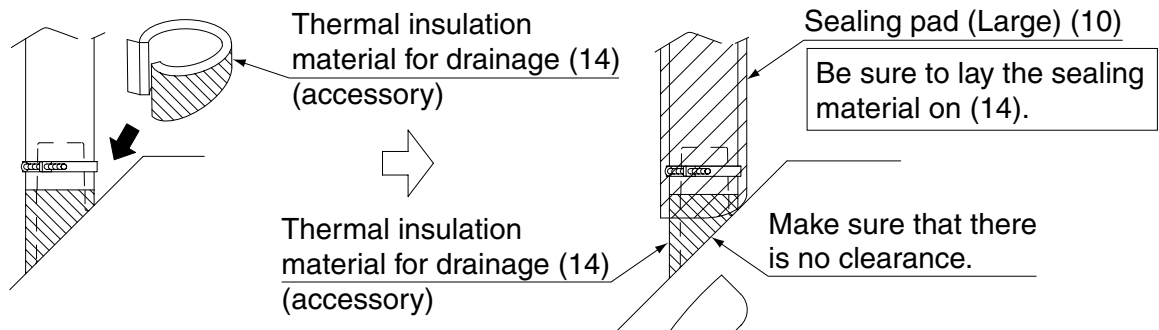

WHEN ELECTRIC WIRING WORK IS NOT FINISHED

⚠ CAUTION

- Electrical wiring work should be done by a certified electrician.
- If someone who does not have the proper qualifications performs the work, perform the following after the test run is complete.
- Remove the control box cover. Connect the single phase power supply (SINGLE PHASE 60Hz 208/230V) to connections L1 and L2 on the terminal block for wiring the units. Connect the ground wire firmly. When carrying out wiring work around the control box, make sure none of the connectors come undone. Be sure to attach the control box cover before turning on the power.
- Put approximately 1/4gal. of water into the drain pan through the blow-off mouth on the left-hand side of the drain socket. Make sure not to pour water over the drain pump or any electric parts including those of the drain pump.
- When the power is turned on, the drain pump will operate and you can check the draining of water through the transparent part of the drain socket. (The drain pump will stop automatically in 10 minutes.) After checking the draining of water, mount the thermal insulation material for drainage (14) and thermal insulate the drain socket.
- After confirming drainage (**Fig. 23, Fig. 24**), turn off the power and remove the power supply.
- Attach the control box cover as before.

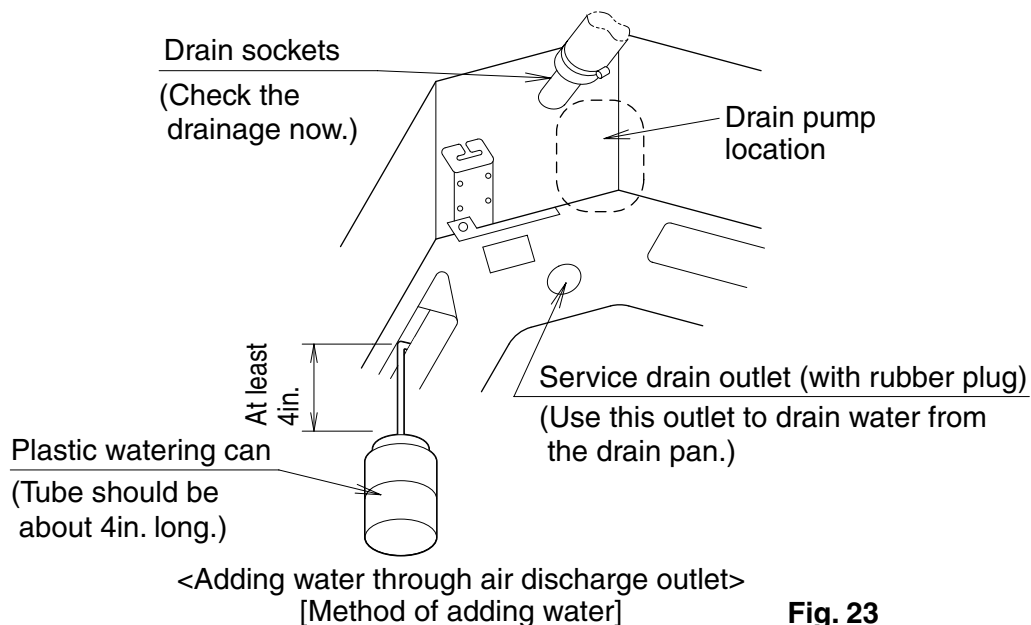

Fig. 23

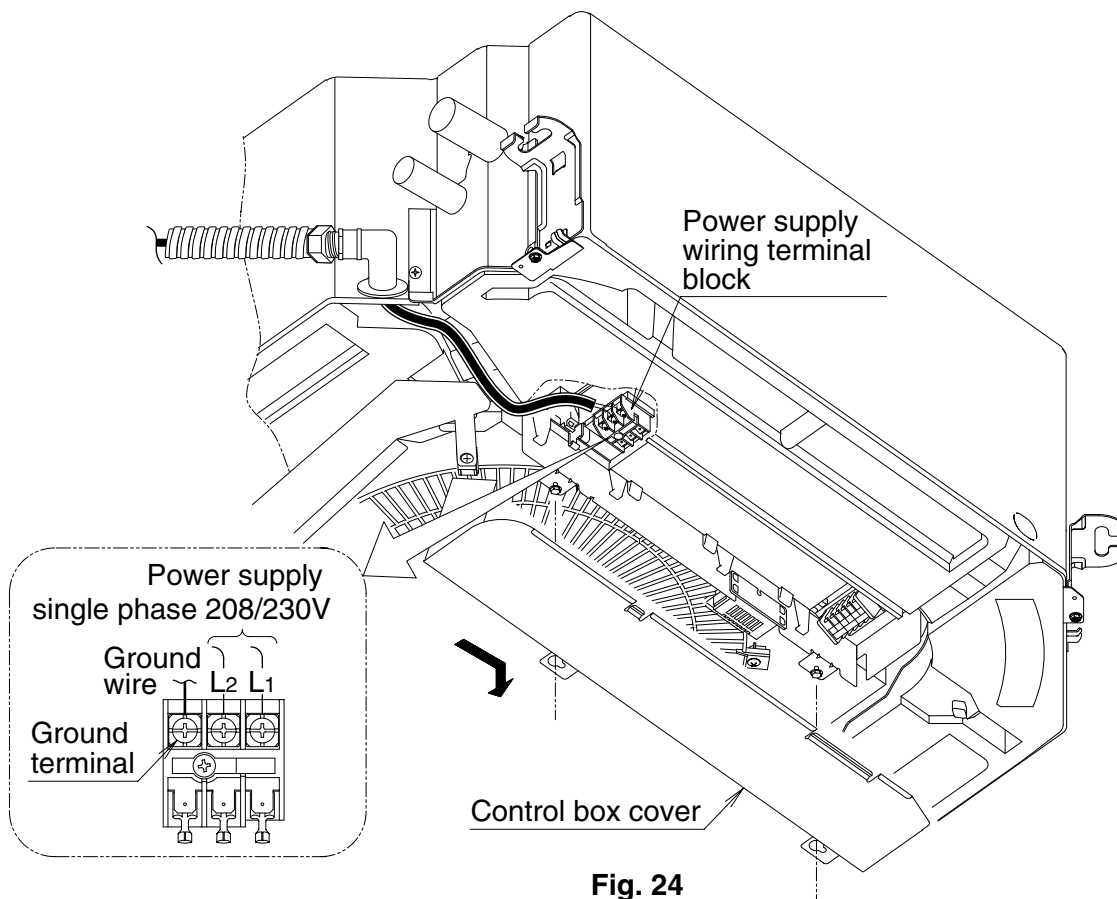

Fig. 24

CAUTION

Drain piping connections

Do not connect the drain piping directly to sewage pipes that smell of ammonia. The ammonia in the sewage might enter the indoor unit through the drain pipes and corrode the heat exchanger.

8. ELECTRIC WIRING WORK

8-1 General instructions

- All field supplied parts and materials and electric works must conform to local codes.
- Use copper wire only.
- For electric wiring work, refer to also "WIRING DIAGRAM" attached to the unit body.
- For remote controller wiring details, refer to the installation manual attached to the remote controller.
- All wiring must be performed by an authorized electrician.
- A circuit breaker capable of shutting down power supply to the entire system must be installed.
- Refer to the installation manual attached to the outdoor unit for the size of power supply electric wire connected to the outdoor unit, the capacity of the circuit breaker and switch, and wiring instructions.
- Be sure to ground the air conditioner.
- Do not connect the ground wire to gas pipes, plumbing pipes, lightning rods, or telephone ground wires.
 - Gas pipes: might cause explosions or fire if gas leaks.
 - Plumbing: no grounding effect if hard vinyl piping is used.
 - Telephone ground wires or lightning rods: might cause abnormally high electric potential in the ground during lightning storms.

8-2 Electrical characteristics

Units				Power supply		Fan motor	
Model	Hz	Volts	Voltage range	MCA	MOP	kW	FLA
FCQ18PAVJU	60	208/230	Max. 253 Min. 187	0.4	15	0.056	0.3
FCQ24PAVJU				0.5	15	0.056	0.4
FCQ30PAVJU				0.6	15	0.056	0.5
FCQ36PAVJU				1.4	15	0.120	1.1
FCQ42PAVJU				1.5	15	0.120	1.2

MCA: Minimum Circuit Ampacity (A) MOP: Maximum Overcurrent Protective Device (A)
 kW: Fan Motor Rated Output (kW) FLA: Full Load Ampacity (A)

8-3 Specifications for field supplied fuses and wire

Power supply wiring		Remote controller wiring Transmission wiring	
Field fuses 	Size	Wire	Size
15A	Wire size must comply with local codes.	Sheathed wire (2 wire)	AWG18 - 16

Allowable length of transmission wirings and remote controller wiring are as follows.

- (1) Outdoor unit - Indoor unit:
Max. 3280ft. (Total wiring length: 6560ft.)
- (2) Indoor unit - Remote controller
Max. 1640ft.

NOTE

1. Vinyl cord with sheath or cable (Insulated thickness : 0.04in. or more)

9. WIRING EXAMPLE AND HOW TO SET THE REMOTE CONTROLLER

9-1 How to connect wires

Connection of wiring between units, ground wire and the remote controller wire (Refer to Fig. 25)

- Wiring the units and ground wire
Remove the control box cover and connect wires of matching number to the terminal block for wiring the units (3 P) inside. And connect the ground wire to the ground terminal. In doing this, pull the wires inside through the hole and fix the wires securely with the included clamp (4) (2 points).
- Remote controller wires (not necessary for slave unit of simultaneous operation system)
Remove the control box cover and pull the wires inside through the hole and connect to the terminal block for remote controller (6 P). (no polarity) Securely fix the remote controller wire with the included clamp (4) (2 points).
- After connection, attach sealing pad (13).
- Be sure to attach it to prevent the infiltration of water from the outside.

[PRECAUTIONS]

1. Use round crimp-style terminals for connecting wires to the power supply terminal block.
If unavailable, observe the following points when wiring.
 - Do not connect wires of different gauge to the same power supply terminal. (Looseness in the connection may cause overheating.)
 - Use the specified electric wire. Connect the wire securely to the terminal. Lock the wire down without applying excessive force to the terminal. (Tightening torque: 1lbf-ft. ±10 %)

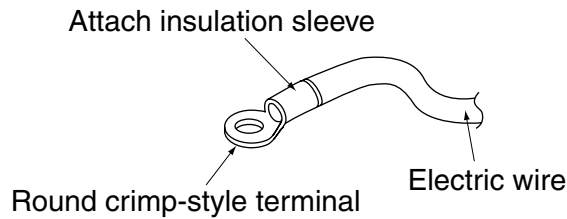

Fig. 25

2. Tightening torque for the terminal screws.

- Use the correct screwdriver for tightening the terminal screws. If the blade of screwdriver is too small, the head of the screw might be damaged, and the screw will not be properly tightened.
- If the terminal screws are tightened too hard, screws might be damaged.
- Refer to the table below for the tightening torque of the terminal screws.

Terminal	Size	Tightening torque
Terminal block for remote controller (6P)	M3.5	0.58 – 0.72lbf-ft
Power supply terminal block (3P)	M4	0.87 – 1.06lbf-ft

When none is available, follow the instructions below.

3. Do not connect wires of different gauge to the same grounding terminal.

Connect wires of the same gauge to both side.

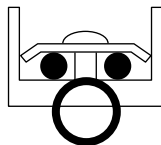

Do not connect wires of the same gauge to one side.

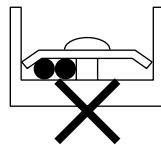

Do not connect wires of different gauges.

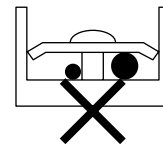

Fig. 26

Looseness in the connection may deteriorate protection.

4. Outside the unit, keep transmission wiring at least 2in. away from power supply wiring. The equipment may malfunction if subjected to electrical (external) noise.
5. For remote controller wiring, refer to the “INSTALLATION MANUAL OF REMOTE CONTROLLER.” attached to the remote controller.
6. **Never connect power supply wiring to the terminal block for remote controller. A mistake of the sort could damage the entire system.**
7. Use only specified wire and tightly connect wires to terminals. Be careful wires do not place external stress on terminals. Keep wiring in neat order and so as not to obstruct other equipment such as popping open the control box cover. Make sure the cover closes tight. Incomplete connections could result in overheating, and in worse case, electric shock or fire.
8. Pass the power supply wire through the attached insulation tube (16) between the outlet of conduit and the power supply terminal, and bind them together with the attached clamp (4). **(Refer to Fig. 27-2)**
9. Use a pair of conduit mounting plate (17) and (18) to connect a conduit to the unit as shown Fig. 27-1.

10. Use a 90° elbow type of conduit with dimensions Fig. 27-1 to prevent it from hitting the swing motor housing of decoration panel.

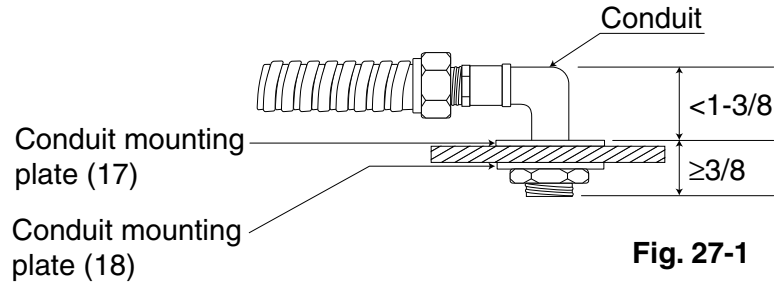

Fig. 27-1

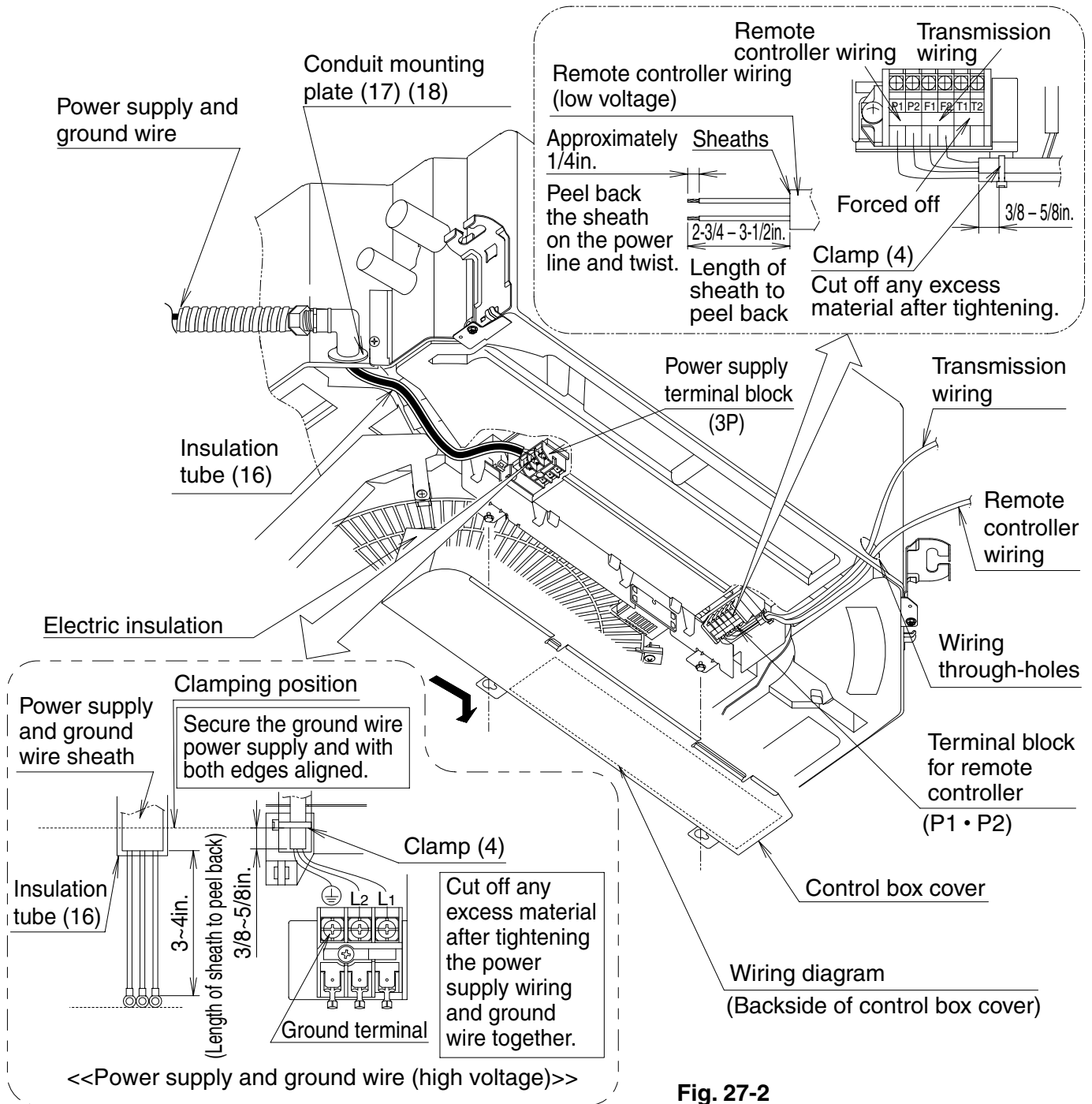

Fig. 27-2

Observe the notes mentioned below when wiring to the terminal block for wiring the units.

CAUTION

- When clamping wiring, use the included clamping material to prevent outside pressure being exerted on the wiring connections and clamp firmly. When doing the wiring, make sure the wiring is neat and does not cause the control box cover to stick up, then close the cover firmly.
- When attaching the control box cover, make sure you do not pinch any wires.
- After all the wiring connections are done, fill in any gaps in the through holes with putty or insulation (procured locally) to prevent small animals and insects from entering the unit from outside. (If they get in, they could cause short circuits in the control box.)
- Outside the unit, separate the low voltage wiring (remote controller wire) and high voltage wiring (power supply, ground, and other power wiring) at least 2in. so that they do not pass through the same place together. Proximity may cause electrical interference, malfunctions, and breakage.

Processing method of wiring through-holes

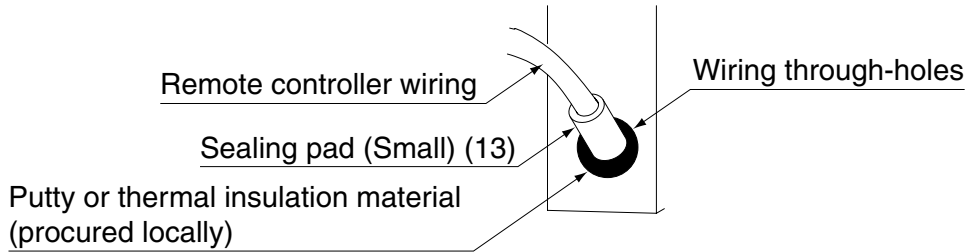

9-2 Wiring example

WARNING

Install a ground fault circuit interrupter.

The installation of a ground fault circuit interrupter is imperative for the prevention of electric shocks and fire accidents.

- Fit the power supply wiring of each unit with a disconnect switch and a maximum overcurrent protective device as shown in the drawing.

COMPLETE SYSTEM EXAMPLE

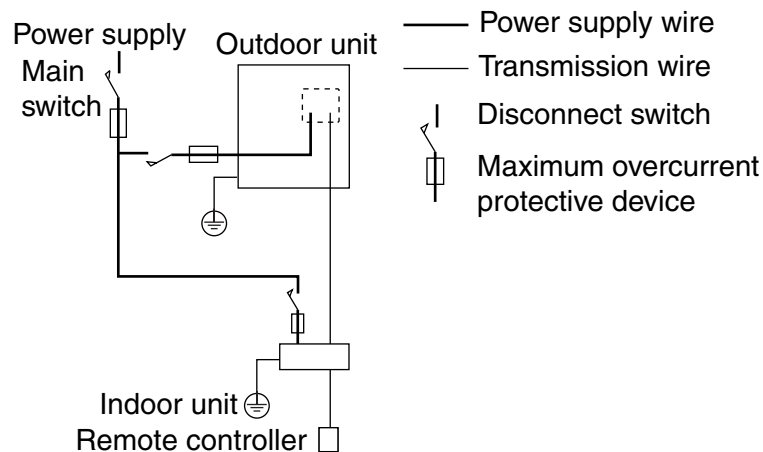

Fig. 28

1. When using 1 remote controller (Normal operation)

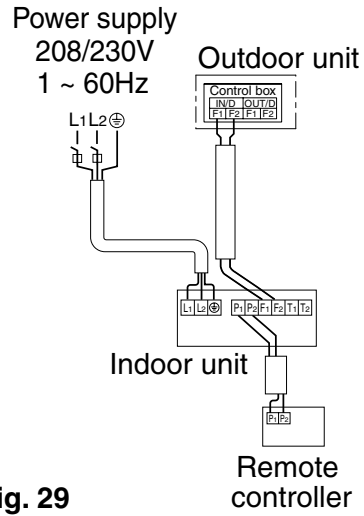

Fig. 29

2. When using 2 remote controllers

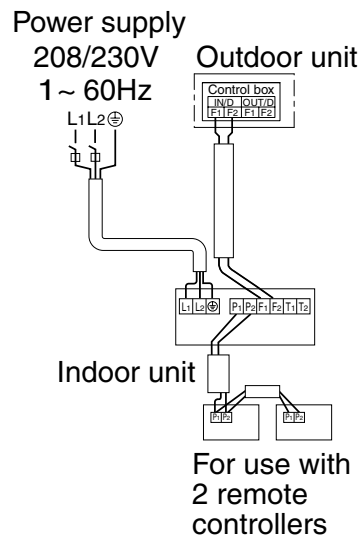

Fig. 30

[PRECAUTIONS]

1. Do not ground the equipment on gas pipes, water pipes or lightning rods, or crossground with telephones. Improper grounding could result in electric shock.

9-3 Control by 2 remote controllers (controlling 1 indoor unit by 2 remote controllers)

- When using 2 remote controllers, one must be set to "MAIN" and the other to "SUB".

MAIN/SUB CHANGEOVER

- The settings of the BRC1E71 remote controller should be switched while referring to the manual supplied with the remote controller.
- In case of the BRC1D71 remote controller.

(1) Insert a \ominus screwdriver into the recess between the upper and lower part of remote controller and, working from the 2 positions, pry off the upper part. (The remote controller PC board is attached to the upper part of remote controller.) **(Refer to Fig. 31)**

(2) Turn the **main/sub changeover** switch on one of the two remote controller PC boards to "S". (Leave the switch of the other remote controller set to "M".) **(Refer to Fig. 32)**

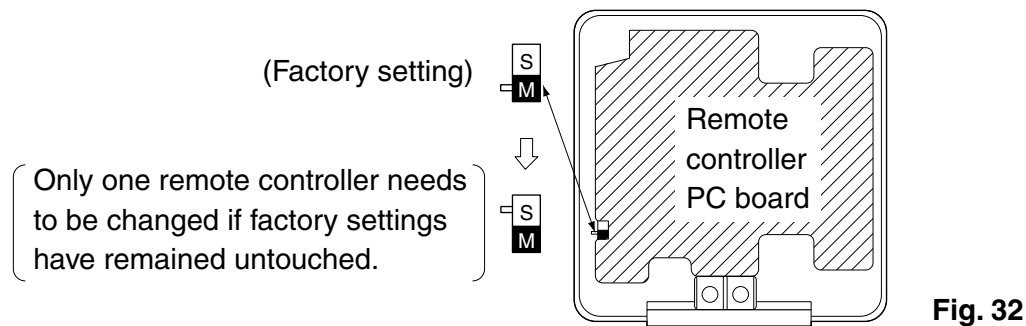
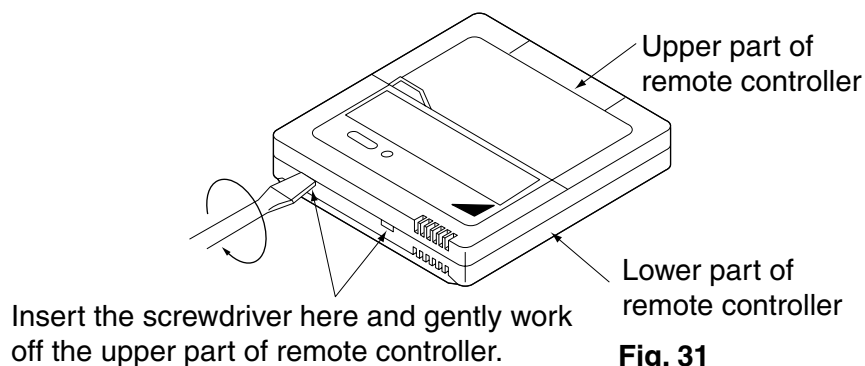

Wiring Method (See "ELECTRIC WIRING WORK")

(3) Remove the control box cover

(4) **Add remote control 2 (slave) to the terminal block for remote controller (P1, P2) in the control box. (There is no polarity.) (Refer to Fig. 30 and 8-3.)**

9-4 Computerized control (forced off and on/off operation)

(1) Wire specifications and how to perform wiring

- Connect the input from outside to terminals T1 and T2 of the terminal block for remote controller.

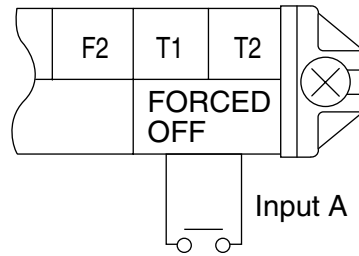

Wire specification	Sheathed vinyl cord or cable (2 wire)
Gauge	AWG18 - 16
Length	Max. 328ft.
External terminal	Contact that can ensure the minimum applicable load of 15 V DC, 1 mA.

(2) Actuation

- The following table explains FORCED OFF and ON/OFF OPERATIONS in response to Input A.

FORCED OFF	ON/OFF OPERATION
Input "ON" stops operation (impossible by remote controllers.)	Input OFF → ON turns ON unit.
Input OFF enables control by remote controller.	Input ON → OFF turns OFF unit.

(3) How to select FORCED OFF and ON/OFF OPERATION

- Turn the power on and then use the remote controller to select operation.

9-5 Centralized control

- For centralized control, it is necessary to designate the group No. For details, refer to the manual of each optional controllers for centralized control.

10. INSTALLATION OF THE DECORATION PANEL

<If performing a test run without attaching the decoration panel, read "11. FIELD SETTING" and "12. TEST RUN" first.>

Refer to the installation manual attached to the decoration panel.

After installing the decoration panel, ensure that there is no space between the unit body and decoration panel.

Note:

Since the electric insulation sheet stacked to the control box cover gets sandwiched between the unit body and decoration panel, when closing the cover, slip the insulation sheet between them first and then attach the cover to the control box.

11. FIELD SETTING

⚠ CAUTION

When performing field setting or test run without attaching the decoration panel, do not touch the drain pump. This may cause electric shock.

- Check that the outdoor unit has been wired properly.

Make sure the control box covers are closed on the indoor and outdoor units.

Field setting must be made from the remote controller and in accordance with installation conditions.

- Setting can be made by changing the “Mode No.,” “FIRST CODE NO.” and “SECOND CODE NO.”
- For setting procedures and instructions, see “Field settings” in the installation manual provided with the remote controller.

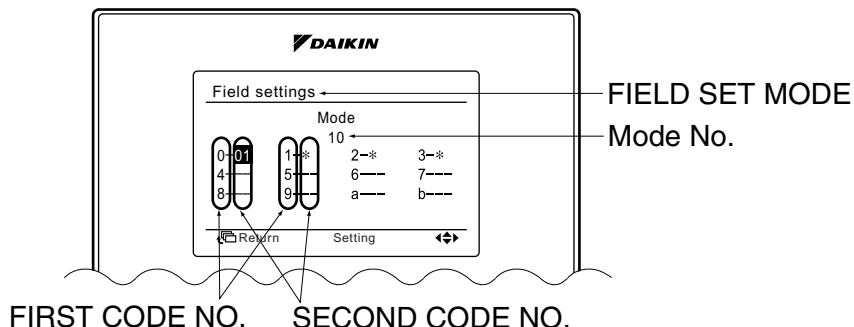

11-1 Setting ceiling height

- Select the SECOND CODE NO. that corresponds to the ceiling height in “Table 4”. (SECOND CODE NO. is factory set to “01”.)

Table 4

		FCQ - PAVJU		Mode No. Note) 1	FIRST CODE NO.	SECOND CODE NO.
		18 · 24 · 30 type	36 · 42 type			
Ceiling height (ft.)	Standard · All round outlet	≤ 8-3/4	≤ 10-1/2	13 (23)	0	01
	High ceiling 1	8-3/4 - 10	10-1/2 - 12			02
	High ceiling 2	10 - 11-1/2	12 - 13-3/4			03

Note:

1. “Mode No.” setting is done in a batch for the group. To make or confirm settings for an individual unit, set the internal mode number in parentheses.
2. The figure of the ceiling height is for the all round outlet. For the settings for four-direction (part of corner closed off), three-direction and two-direction outlets, see the installation manual supplied with the sealing member of air discharge kit sold separately.

11-2 Setting of air direction

- See the installation manual supplied with the sealing member of air discharge outlet kit sold separately technical guide, for ceiling height settings for two and three-direction air discharge. (The SECOND CODE NO. is factory set to “01” (all round outlet) before shipping.)

11-3 Settings for optional accessories

- When installing optional accessories, refer to the installation manual provided with them and make necessary settings.

11-4 Setting of air filter sign

- Remote controllers are equipped with liquid crystal display air filter signs to display the time to clean air filters.
- Change the SECOND CODE NO. according to “Table 5” depending on the amount of dirt or dust in the room. (SECOND CODE NO. is factory set to “01” for filter contamination-light.)

Table 5

Setting	Spacing time of display air filter sign (long life type)	Mode No.	FIRST CODE NO.	SECOND CODE NO.
Air filter contamination-light	Approx. 2500 hrs	10 (20)	0	01
Air filter contamination-heavy	Approx. 1250 hrs			02
No Display			3	

Note:

1. “Mode No.” setting is done in a batch for the group. To make or confirm settings for an individual unit, set the internal mode number in parentheses.
 2. Make settings for “No Display” in cases where no cleaning display is required, e.g., at the time of regular maintenance servicing.
- The air conditioner is provided with a long life filter as a standard accessory. Explain to the customer the necessity of cleaning the filter periodically along with the set time for filter cleaning for the prevention of clogging.

12. TEST RUN

Refer to the installation manual of the outdoor unit.

- The operation lamp of the remote controller will flash when a malfunction occurs. Check the malfunction code on the liquid crystal display to identify the point of trouble. An explanation of malfunction codes and the corresponding trouble is provided in the installation manual attached to the outdoor unit or the service manual.

If any of the items in “Table 6” is displayed, there may be a problem with the wiring or power supply, so check the wiring again.

Table 6

Remote controller display	Contents
“  ” is lit up	<ul style="list-style-type: none"> • There is a short circuit at the FORCED OFF terminals (T1, T2).
“U4” is lit up “UH” is lit up	<ul style="list-style-type: none"> • The power supply on the outdoor unit is off. • The outdoor unit has not been wired for power supply. • Incorrect wiring for the transmission and / or the FORCED OFF.
No display	<ul style="list-style-type: none"> • The power supply on the indoor unit is off. • The indoor unit has not been wired for power supply. • Incorrect wiring for the remote controller, the transmission, and / or the FORCED OFF.

- If the decoration panel is installed on the indoor unit during the test run, check the operation of the swing flap on the panel.
- In order to protect the indoor unit, instruct the customer not to operate the air conditioner until the interior work is completed if the interior work has not been finished at the end of the test run. (If the air conditioner is operated, substances discharged from the paint, adhesive, etc. can contaminate the indoor unit, and they may cause splashing or leakage of water.)

NOTE

- After the test run is finished, check the items listed in “2. Items to be checked at time of delivery”.

DAIKIN AC (AMERICAS), INC.

1645 Wallace Drive, Suite 110
Carrollton, TX 75006 USA

info@daikinac.com
www.daikinac.com

DAIKIN INDUSTRIES, LTD.

Head office:

Umeda Center Bldg., 2-4-12, Nakazaki-Nishi,
Kita-ku, Osaka, 530-8323 Japan

Tokyo office:

JR Shinagawa East Bldg., 2-18-1, Konan,
Minato-ku, Tokyo, 108-0075 Japan

